

SERIES 2

Eliteboard

User Guide

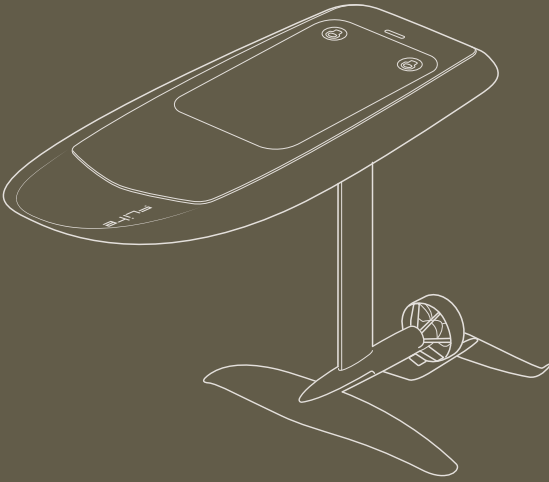

Important

IN ORDER TO OPERATE THE PRODUCT CORRECTLY AND MINIMISE THE CHANCES OF DAMAGE, SERIOUS INJURY OR DEATH, IT IS ESSENTIAL TO READ AND FOLLOW ALL OF THE INSTRUCTIONS AND WARNINGS IN THE USER GUIDE PRIOR TO ASSEMBLY, SETUP OR USE. BY USING A FLITEBOARD YOU AGREE THAT YOU DO SO AT YOUR OWN RISK.

CAUTION: THIS PRODUCT HAS BEEN KNOWN TO DRAMATICALLY IMPROVE YOUR LIFE AND HAPPINESS LEVELS.



For the latest version of this guide visit

support.fliteboard.com



Watch our video tutorials at

fliteboard.com/video



Authorised Flite Service, Resellers and Fliteschools

fliteboard.com/locations



Download Flite APP from App Store IOS only, V10.7 or higher. Android version coming soon - check the Google Play store.

apps.apple.com/au/app/fliteboard/id1499441319



Watch our Flite APP update video

tinyurl.com/yb3vudw8



Post-storage checklist

tinyurl.com/y7vv5brg



Material Safety Data Sheets

tinyurl.com/yczdbueu



Fliteboard support

support.fliteboard.com



Fliteboard contact

fliteboard.com/contact

Fliteboard User Guide

Safety & disclaimer

- 6 Warning
- 6 Intended use
- 7 Propulsion system
- 7 Hydrofoil system
- 7 Learning to Fliteboard
- 10 Flitecell

Warranty and Compliance

- 11 Warranty
- 11 Repairs
- 11 Shipping compliance

Unboxing

- 12 Box 1: Fliteboard
- 13 Box 2: Flitecell
- 14 Box 3: eFoil travel bag
- 15 Box 3: Accessories pouch

Getting started

- 17 Charging Flite Controller
- 18 Charger procedure
- 19 Charging Flitecell
- 19 Flitecell Chargers
- 19 Charger indicator guide
- 20 Fliteboard AIR assembly
- 22 Connect eFoil to Fliteboard
- 23 Connect the fuselage tail
- 24 Connect the wing
- 24 Connect the Stabiliser Wing
- 25 Connect Flitecell to Fliteboard
- 26 Turning on Fliteboard
- 27 Download Flite App and update

- 27 Performing first update
- 28 Connect Flite App to Fliteboard and eFoil
- 29 Connect Flite App to Flite Controller
- 30 Capturing sessions
- 31 Flite Controller overview
- 31 Connect Flite Controller
- 34 Flite Controller screen guide
- 36 Pairing Flite Controller with Fliteboard
- 38 Arm motor / unlock Flite Controller

Get Fliteboarding

- 39 Preparation
- 39 Select a suitable riding location
- 39 Arm the Flite Controller
- 40 Engage the motor and get moving
- 41 Getting to your knees
- 42 Standing up
- 43 Foiling for the first time

Foiling Pro tips

- 44 Foiling through turns

Maintenance and Storage

- 46 Fliteboard, PRO, ULTRA
- 47 Fliteboard AIR
- 48 Fliteboard Controller
- 49 Flitecell
- 50 Shipping and Transport
- 51 Trouble shooting guide
- 52 Technical Specifications
- 56 Warranty Registration / Details of Purchase
- 57 Maintenance Schedule

Important rider safety

1 Read the manual and watch the How to Fliteboard video

Before attempting to Fliteboard for the first time, read this manual and pay special attention to the warnings and disclaimers. Most injuries can be avoided by using proper technique when learning. Watch the How to Fliteboard video at fliteboard.com/video



2 Wear a helmet and PFD

Wear an approved and certified helmet and PFD (Personal Flotation Device) at all times.

There may be specific rules and legal requirements in your location that also apply.



3 Avoid contact with the wings and propeller

Avoid contact with the wings, mast and propeller which all have sharp edges. Take care to not kick the wings when climbing on to the board.

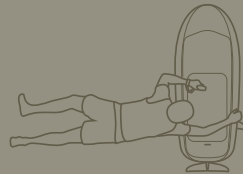

4 Keep distance

Keep well clear of other water users at all times. Check regulations for vessel operating distance rules in your area. Always be on the look out for swimmers, other vessels or obstacles when riding which may be obscured by waves or glare.

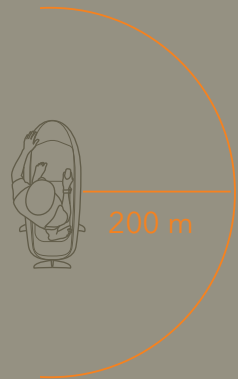

5 Release the throttle

Release the trigger immediately on committing yourself to a fall. This will stop the propeller and reduce the forces which could otherwise lead to a more extreme crash. Practice this skill when learning with the goal of stopping the propeller before you hit the water in a fall.

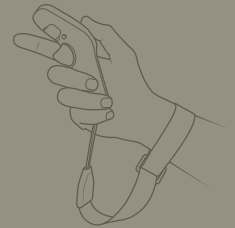

6 Fall away from Fliteboard

The best way to avoid injury is to practice the correct falling technique. As soon as you begin to lose balance, purposely fall in the direction the board is already falling. You will then likely end up in the water on the opposite side to the hydrofoil assembly. Like being on stilts - it is impossible to regain balance once your weight is no longer above the hydrofoil wings (unless you are turning).

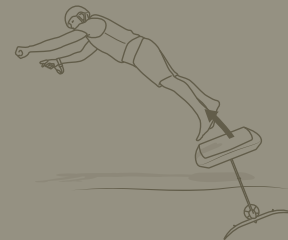

Flitecell

Flitecell is a carefully engineered water resistant unit. If the Flitecell is damaged (for example during transportation or handling) the seal may become compromised. A damaged Flitecell that comes into contact with water may result in internal damage including corrosion which could result in a fire and/or explosion.

USE FLITECELL AT YOUR OWN RISK.

SIGNS OF A COMPROMISED FLITECELL:

- SIGHT GLASS LABEL HAS TURNED RED, INDICATING WATER INGRESS
- LOOSE SCREWS/RIVETS
- CONNECTOR COMING LOOSE
- CRACK IN HOUSING/CASE
- DEFORMATION
- UNUSUAL SMELL
- HIGH TEMPERATURE DURING CHARGING (60° C OR MORE)

CAREFULLY INSPECT FLITECELL BEFORE EACH USE.

IF A FLITECELL CASING HAS VISIBLE DAMAGE AND THE FLITECELL FALLS INTO WATER, TAKE IT OUT IMMEDIATELY AND PUT IT IN A SAFE AND OPEN AREA. MAINTAIN A SAFE DISTANCE FROM FLITECELL UNTIL IT IS COMPLETELY DRY. DON'T USE FLITECELL AGAIN AND DISPOSE OF FLITECELL PROPERLY.

FLITECELL MUST BE USED IN TEMPERATURES FROM 0°C TO 40°C. USE OF FLITECELL IN ENVIRONMENTS ABOVE 40°C MAY LEAD TO AN OVERHEATED BATTERY. USE OF FLITECELL BELOW 0°C CAN LEAD TO PERMANENT FLITECELL DAMAGE.

ALWAYS KEEP FLITECELL DRY. IF FLITECELL HAS BEEN EXPOSED TO WATER, PLACE IN A COOL DRY PLACE.

DO NOT DROP OR STRIKE FLITECELL.

DO NOT PLACE HEAVY OBJECTS ON FLITECELL OR THE CHARGER.

DO NOT CHARGE OR USE A DAMAGED FLITECELL. IF YOUR FLITECELL IS COMPROMISED, CONTACT FLITEBOARD OR AN AUTHORIZED FLITEBOARD DEALER FOR FURTHER ASSISTANCE.

DO NOT USE FLITECELL IF IT WAS INVOLVED IN A CRASH OR HEAVY IMPACT.

DO NOT USE A NON FLITECELL BATTERY. ANY DAMAGE CAUSED BY A NON-OFFICIAL BATTERY WILL NOT BE COVERED BY WARRANTY.

DO NOT DISASSEMBLE FLITECELL. DOING SO COULD CAUSE AN INJURY OR LEAD TO A WATER LEAK OR FIRE. TAMPERING WITH THE FLITECELL BATTERY WILL VOID THE WARRANTY.

DO NOT HEAT FLITECELL. KEEP AWAY FROM HEATING SOURCES AND OUT OF DIRECT SUNLIGHT.

DO NOT PUT FLITECELL IN A MICROWAVE OVEN, FREEZER OR IN A PRESSURISED CONTAINER.

DO NOT OPEN FLITEBOARD LID UNDER ANY CIRCUMSTANCES WHILST IN WATER OR WITH WET HANDS.

IN CASE OF A FLITEBOARD OR FLITECELL FIRE, EXTINGUISH WITH:

- COLD WATER WITHOUT ADDITIVE
- DRY POWDER IN LARGE AMOUNT (USE METAL FIRE EXTINGUISHER POWDER OR DRY SAND IF ONLY A FEW CELLS ARE IMPACTED)

FOR FURTHER INFORMATION ABOUT INCIDENT RESPONSE AND DISPOSAL. PLEASE REFER TO THE MSDS.

DISPOSE OF THE FLITECELL IN SPECIFIC RECYCLING BOXES ONLY AFTER A COMPLETE DISCHARGE. DO NOT PLACE FLITECELL IN REGULAR TRASH CONTAINERS. STRICTLY FOLLOW YOUR LOCAL REGULATIONS REGARDING THE DISPOSAL AND RECYCLING OF BATTERIES.

Warranty

Fliteboard comes with a Limited Warranty which covers defects in materials or workmanship of the product and aligns to relevant consumer laws of the location of purchase. Further details about the Fliteboard Limited Warranty are set out in your Purchase Agreement.

For our Australian customers: Our goods come with guarantees that cannot be excluded under the Australian Consumer Law. You are entitled to a replacement or refund for a major failure and compensation for any other reasonably foreseeable loss or damage. You are also entitled to have the goods repaired or replaced if the goods fail to be of acceptable quality and the failure does not amount to a major failure. Please ensure that you complete the Warranty Registration/Details of Purchase card at the end of this manual.

Maintaining your Warranty

Fliteboard is more than a surfboard. Similar to any other electric powered vehicle, it needs to be serviced regularly and maintained to ensure good working order and to prevent breakage.

In order to maintain the above warranty, **a mandatory initial 6 month service of the eFoil is required.**

Only an authorised service partner or Fliteboard HQ can carry out this service, including the ongoing schedule of service, every 12 months or 100hrs thereafter and any warranty or non-warranty repairs. To find your nearest service partner, visit fliteboard.com/locations

Fliteboard has been extensively tested with riders weighing up to 100kg. Heavier, experienced riders, may be able to use

Fliteboard, however our factory specified limit for warranty and other purposes is 100kg.

Initial 6 month service

This is to check seals, oil, overall inspection of the eFoil system and Flite Controller.

Carefully pack these items in the original eFoil Travel Bag including foam inserts (110 x 71 x 28cm. 6.5kgs) Send to an Authorised Partner or Fliteboard HQ (whichever is closest). Flitecell, wings, chargers or other accessories are not required and should not be included.

Please refer to our 'Packing your Fliteboard' video and help documentation via support.fliteboard.com

The Fliteboard Limited Warranty is void if your Fliteboard has missed the required service schedule.

Repairs

If subjected to damage, the epoxy construction boards (Fliteboard, PRO and ULTRA) can be repaired by your local surfboard repair specialist. The inflatable construction Fliteboard AIR may be repaired using the included repair kit.

Shipping compliance

Shipping batteries can be illegal and dangerous if not done in accordance with dangerous goods shipping regulations. Always consult an appropriate specialist before shipping your Flitecell. Refer to the included MSDS regarding shipping your Flitecell by air or sea.

What's in the box

You will receive your Fliteboard in three separate shipment packages.

Box 1: Fliteboard

Within the included padded board bag you will find either Fliteboard, Fliteboard PRO, Fliteboard ULTRA or Fliteboard AIR (depending upon your choice).

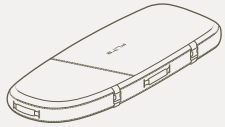

Fliteboard ULTRA travel bag



Fliteboard ULTRA



Flitecell travel bag

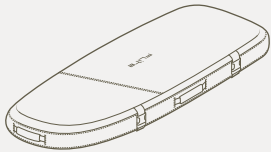

Fliteboard PRO travel bag

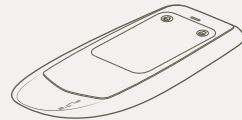

Fliteboard PRO

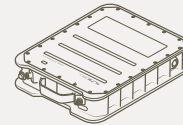

Flitecell Explore

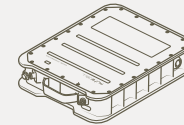

Flitecell Sport

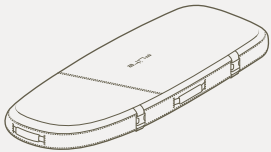

Fliteboard travel bag



Fliteboard

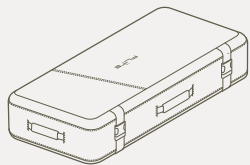

Fliteboard AIR travel bag

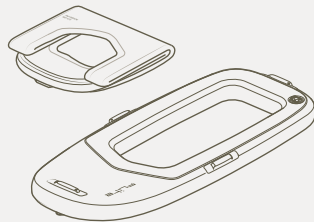

Fliteboard AIR

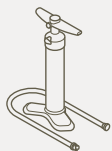

Fliteboard AIR pump and hose

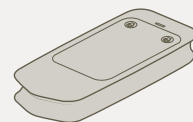

Fliteboard AIR core

Box 2: Flitecell

Box 3: Flite eFoil travel bag

Within the included travel case you will find the following components*

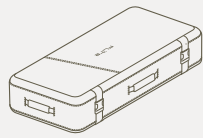

eFoil travel bag

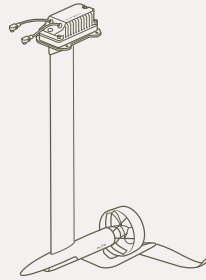

eFoil system including:

- Flitebox
- Flite propulsion system
- Fuselage tail

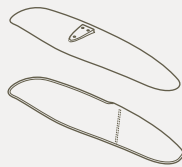

Cruiser 1100 Wing + cover

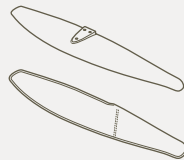

Flyer 800 Wing + cover



290 Stabiliser Wing + cover

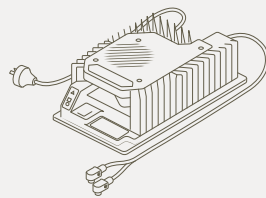

Flitecell Premium 25A Charger

Box 3: Accessories pouch

Within the included accessories pouch you will find the following components:

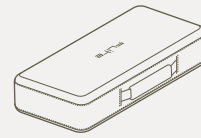

Accessories pouch



Tef-Gel

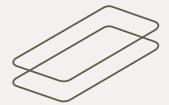

O-Ring + spare

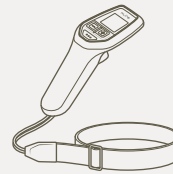

Flite Controller

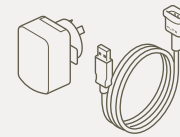

Flite Controller USB wall charger and charging cable

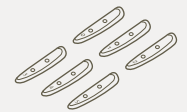

Stabiliser Wing shims 6 x styles (0-5)

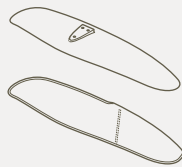

Cruiser 1100 Wing + cover

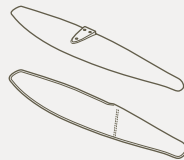

Flyer 800 Wing + cover



Hex key 4mm

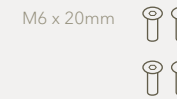

M6 x 20mm



M6 x 16mm

eFoil

Tail



M6 x 40mm



M6 x 30mm



M6 x 35mm



M6 x 25mm



M6 x 20mm

Cruiser 1100 Wing

Flyer 800 Wing

290 Stabiliser Wing

*Actual wing choice and related screws, mast length, battery and charger type are dependent on your specific configuration.

Getting started

The best way to learn to Fliteboard is to find a Fliteschool in your area. Locate your nearest Fliteschool at fliteboard.com/fliteschool

Watch the Fliteboard video guides at fliteboard.com/video

In order to operate the product correctly avoiding damage or serious injury it is essential to read and follow all instructions and warnings in the user guide prior to assembly, setup or use.

IT IS BEST TO ASSEMBLE YOUR BOARD IN A CLEAN, DRY ENVIRONMENT.

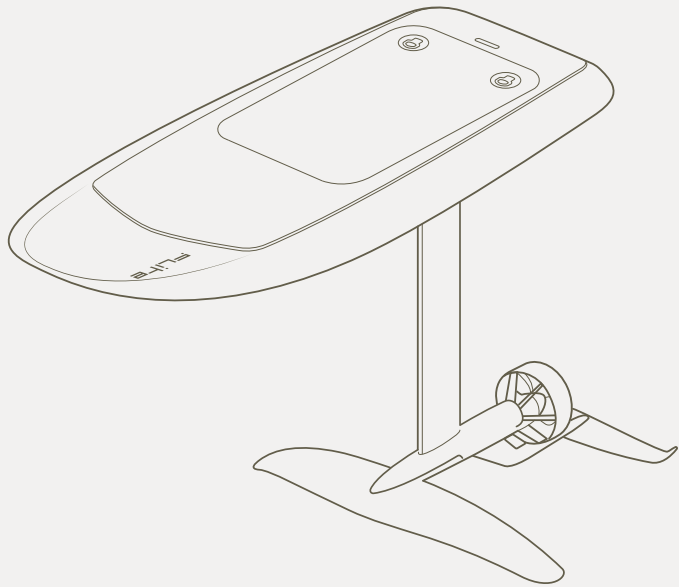

Charging Flite Controller

- 1 Remove Flite Controller from the accessories pouch. (Located in the eFoil bag).
- 2 Remove Flite Controller USB Wall Charger and Charging Cable from the accessories pouch.
- 3 Carefully peel out the rubber cover on the underside of Flite Controller. Attach the magnetic charging plug, ensuring the charging pins are connected.
- 4 Plug in the USB Wall Charger and turn on. When the Flite Controller is charging correctly, the screen will show a charging message. After a few minutes the screen will hibernate to speed the charging process. Be careful not to disconnect the magnetic charging plug whilst charging. Always check to ensure the Flite Controller is at least 50% charged before each use.

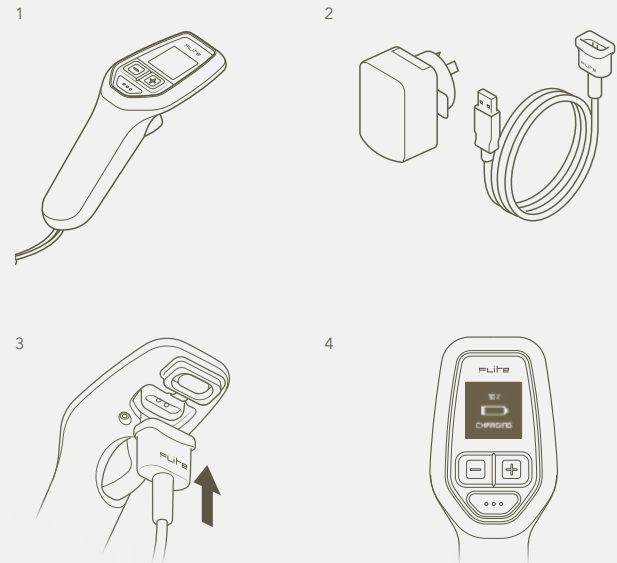

Flitecell Charger procedure

DO NOT COVER THE CHARGER OR INTAKE DURING CHARGING. THE CHARGER SHOULD BE PLACED OUT OF THE REACH OF CHILDREN. CHARGE IN AN INDOOR AREA WITH GOOD VENTILATION AND HEAT DISSIPATION.

DO NOT CHARGE IN HUMID, HIGH TEMPERATURE CONDITIONS. DO NOT CHARGE NEAR FLAMMABLES OR EXPLOSIVES. DO NOT DISASSEMBLE THE CHARGER: THERE IS A DANGER OF HIGH VOLTAGE IN THE CHARGER CASE.



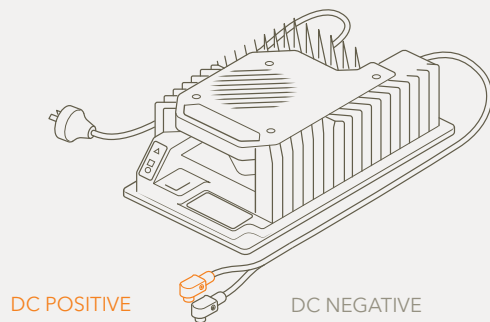

FLITEBOARD DOES NOT BEAR ANY RESPONSIBILITY FOR INCORRECT USE OF THE CHARGER. USERS MUST OPERATE THE CHARGER ACCORDING TO THE INSTRUCTION MANUAL.

ALWAYS KEEP THE RED TERMINAL CAPS ON THE FLITECELL WHEN NOT CONNECTED TO THE BOARD/CHARGER.

Flitecell Premium 25A



Flitecell Premium 25A Indicator Guide

	Power on	
	Flashing green	Charging
	Solid red See charger manual	Charger fault
	Flashing amber See charger manual	External error
	Flashing green Solid green	USB port active Safe to remove USB flash drive

Charging Flitecell

- 1 Remove Flitecell from its travel bag.
- 2 Place Flitecell in a cool dry location away from flammable or hot items.
- 3 Connect Flitecell charger plugs to Flitecell terminals ensuring to connect the orange (positive) connector to the orange terminal first and the black (negative) connector to the black terminal.
- 4 Check that connections have been made correctly. Plug the charger in the wall socket. A supplied magnet located in the accessories pack, is required to be placed on Flitecell, as shown by arrow, (5 - 10 seconds) to activate charging. If the magnet has been misplaced, you can use the base of Flite Controller to initiate charging.
- 5 The charger will automatically turn off when the charging process is complete.

FLITECELL IS A POWERFUL BATTERY CONTAINING A SIGNIFICANT AMOUNT OF ENERGY. CHARGING A DAMAGED FLITECELL CAN RESULT IN A FIRE OR EXPLOSION. ALWAYS INSPECT THE FLITECELL BEFORE CHARGING. CHARGE THE FLITECELL UNDER SUPERVISION, IN A SAFE LOCATION, AWAY FROM DIRECT SUNLIGHT, MOISTURE AND AWAY FROM FLAMMABLE OBJECTS AND SURFACES.

THE BATTERY MANAGEMENT SYSTEM (BMS) BALANCES AND OPTIMISES FLITECELL DURING EACH CHARGE CYCLE.



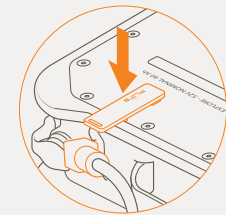
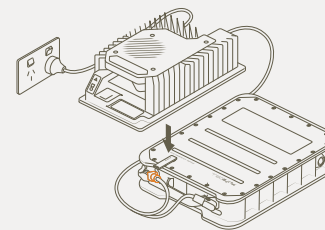





IT IS RECOMMENDED TO LEAVE THE FLITECELL CONNECTED TO A POWERED OFF CHARGER AFTER A FULL CHARGING CYCLE, WITH THE MAGNET STILL CONNECTED (THIS KEEPS THE FLITECELL ON ONLY). THIS ENSURES THAT BOTH THE TERMINALS +/- ARE PROTECTED FROM SHORTING AND THE CELLS WITHIN THE FLITECELL CONTINUE TO SELF-BALANCE BETWEEN USE.



MAGNET PLACED TO ACTIVATE CHARGING

Flitecell light

Light meaning

	Red light flashes	Capacity 0% - 10%
	Red light on	Capacity 10% - 20%
	Green light on	Capacity is 20% - 35%
	Green light flashing	Capacity 0% - 35% + charging
	Two green lights on	Capacity 35% - 65%
	One on + one flashes	Capacity 35% - 65% + charging
	Three green lights on	Capacity 65% - 100%
	Two on + one flashes	Capacity 65% - 100% + charging

Fliteboard AIR assembly

- 1 Unroll Fliteboard AIR bladder face down.
- 2 Place the rigid core (Flitebox cavity side up) on a flat surface.
- 3 Slide bladder onto core from front end first.

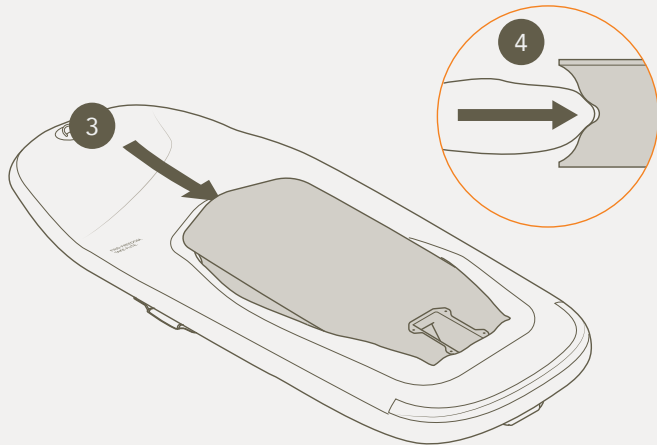

- 4 Ensure bladder is well tucked into the recess along the front edge of the core.
- 5 Carefully stretch bladder over one rear corner first.

NOTE THAT THE REAR UNDERSIDE EDGES OF THE CORE ARE DELIBERATELY SHORTER THAN THE TOP FACE TO MAKE FITMENT OF THE BLADDER EASIER.



Stretch the bladder over the last corner. Again, be careful that the bladder is positioned evenly and not creased or caught.

- 6 Check bladder is seated correctly around the core before carefully flipping the Fliteboard AIR over.

PLACE ON A SMOOTH, SOFT SURFACE TO AVOID SCRATCHING THE CARBON FINISH ON THE CORE.

WHEN FLIPPING THE FLITEBOARD AIR OVER, BE SURE THAT THE ORANGE O-RING IS SEATED CORRECTLY AND STAYS IN PLACE.

Inflating the Fliteboard AIR

- 1 Twist the valve cap anti-clockwise to remove.
- 2 To inflate, push the central valve down.
- 3 Twist anti-clockwise to release.
- 4 The valve will pop up. This ensures the bladder will not deflate when you remove the hose after inflation.

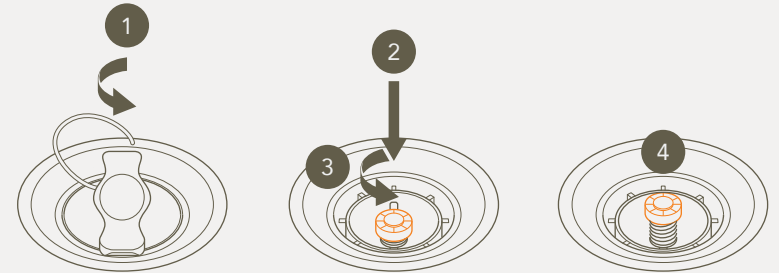

- 5 Connect pump hose to valve and inflate bladder to 15 - 16 PSI. THIS IS IMPORTANT FOR OPTIMUM PERFORMANCE AND SAFETY.

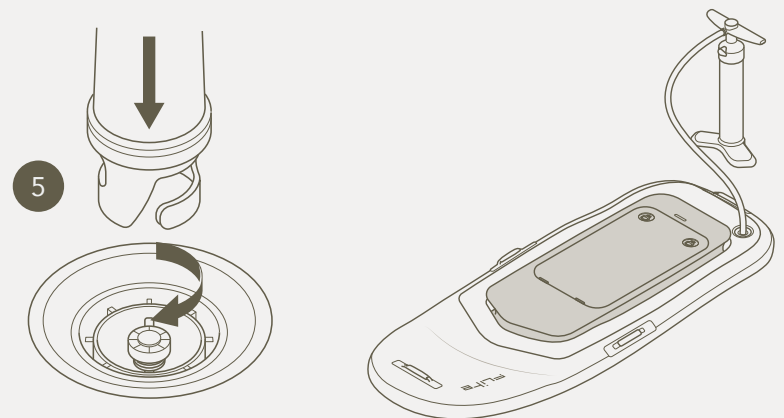

- 6 Once inflated to 15 - 16 PSI, twist the pump hose anti-clockwise to remove and re-fit the valve cover cap. When disconnecting the pump hose, no air should escape from the valve. If the bladder deflates you must release the central valve (see step 2) and re-inflate. Fliteboard AIR is now inflated.

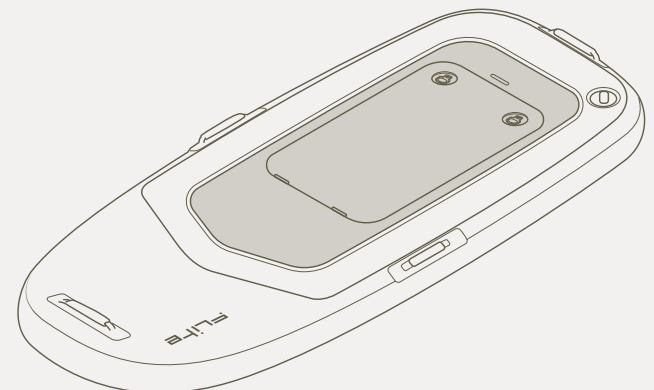

Connect the eFoil to Fliteboard

- 1 Remove the Fliteboard from its bag and place upside down on the bag or other protective surface. Locate the Flitebox cavity on the bottom of the board and ensure the 4 retaining screws are removed.
- 2 Check to ensure the orange o-ring is inserted, properly seated in the Flitebox cavity o-ring groove, clean and free of sand, grit or water.
- 3 Carefully lift the eFoil from its bag and place the Flitebox into the cavity. While doing this ensure the power cables feed through into the Fliteboard cavity.
- 4 Ensure the Flitebox is properly seated in the cavity and flush with the board surface.
- 5 Add a thin layer of Tef-Gel to the 4 x 20mm Stainless Steel Hex fasteners. Tighten them in a cross pattern, first using your fingers to ensure the threads are properly engaged, and then using the supplied hex key. Use a torque of 6 Nm to tighten the fasteners.
- 6 Medium force needs to be applied when using the long arm of the hex key to ensure the fasteners are tight.
- 7 When properly tightened, the eFoil should be secured and the o-ring compressed. Failure to properly tighten the fasteners or fit the o-ring will result in a board leak.
- 8 Be careful not to over-tighten the fasteners as this could result in stripped threads or damaged fasteners.

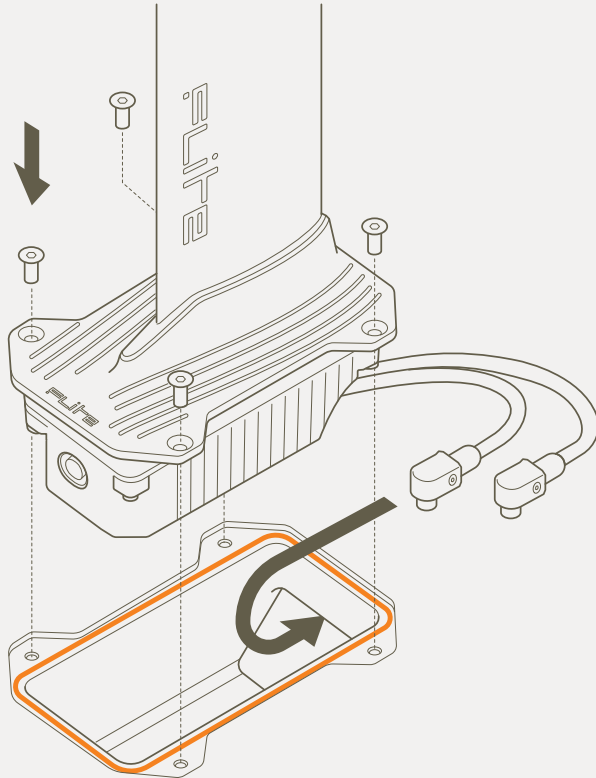

Connect the fuselage tail

- 1 With the board upside down and the eFoil connected, take the 20cm long aluminium fuselage tail from the travel bag and insert into the fin under the propeller guard. Add a light cover of Tef-Gel to the tail connection.
- 2 Add a thin layer of Tef-Gel from the tube supplied to the thread of the supplied 16mm fastener bolt and carefully tighten using the hex key using torque of 6 Nm.

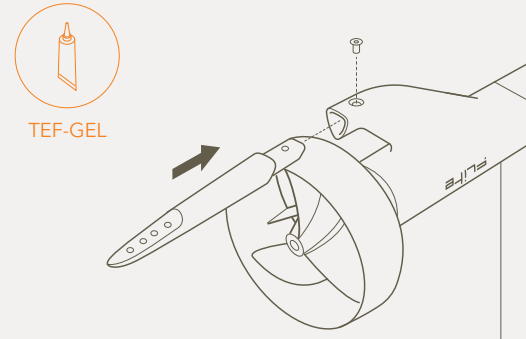

Connect the Wing

- 1 Remove your front wing from the travel bag and from its wing cover (if attached - depending on model).
- 2 Place the wing in position as shown.
- 3 Insert the 3 fasteners taking care to ensure the correct set is being used for the particular wing model you are fitting (Refer to page 15). ALWAYS add Tef-Gel to the fasteners first. The fasteners should extend by approximately 6-8mm through the Wing when placed in the countersunk holes.
- 4 Tighten the fasteners with the supplied hex key, ensuring the fasteners are tight enough that the wing cannot move or wobble significantly during use. Use a torque of 6 Nm to tighten the fasteners.

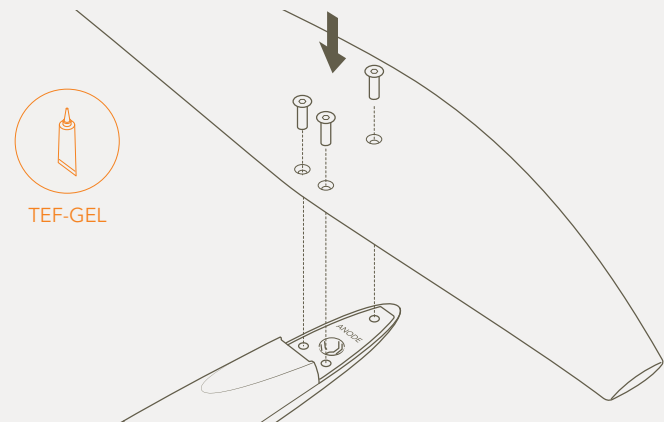

Connect the Stabiliser Wing

- 1 Take the Stabiliser Wing from the travel bag and remove the wing cover.
- 2 Take the correct Stabiliser Wing shim from the accessories pouch and fit between the Stabiliser Wing and the fuselage tail.
- 3 To ensure correct mounting, direction and placement, the wing when installed correctly should have the wings tips facing away from you (the countersunk thread is an indication of this). The correct direction, is that of the rounded, curved leading edge facing the front wing.

ALWAYS ADD TEF-GEL TO THE STAINLESS STEEL FASTENERS THAT ARE BEING INSERTED INTO THE ALUMINIUM. IF LEAVING WINGS ATTACHED FOR EXTENDED PERIODS, ENSURE THAT YOU LOOSEN FASTENERS AND RE-APPLY TEF-GEL EVERY FEW WEEKS. FAILURE TO DO SO MAY RESULT IN CORROSION AND DAMAGE TO YOUR EFOIL FASTENER INSERTS.

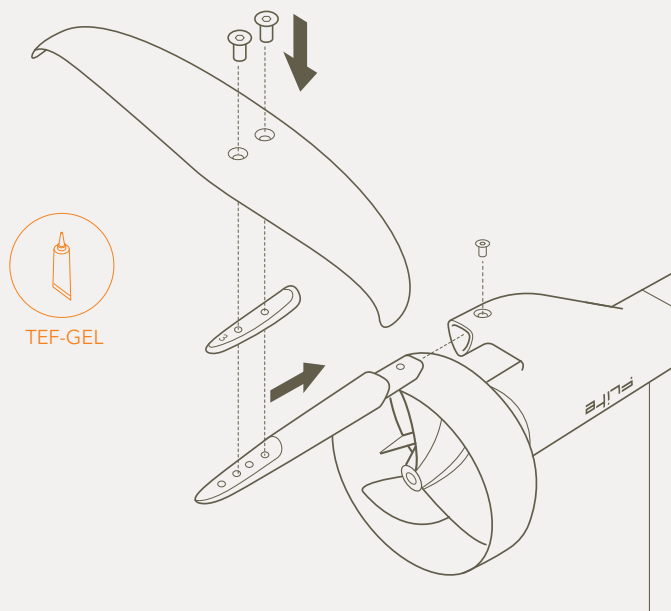

PRO TIP We have supplied 0, 1, 2, 3, 4 and 5 degree shims for you to experiment with to customise your ride. Which shim suits best depends on many aspects such as: preferred riding style, preferred riding speed, riding conditions, skill level and personal preference changing shims alters the amount of stabilising downforce provided by the tail, and also impacts the balance point of the foil and responsiveness. Beginners should start with 1 or 2 and adjust based upon preference. Lower shim numbers allow faster speeds without too much front foot pressure, higher shim numbers create more stability and responsiveness, but lead to more lift at high speeds.

Connect Flitecell to Fliteboard

With the eFoil, fuselage tail and wings attached, it's time to carefully turn your board over so it stands on BOTH the front wing and nose of the board.

- 1 Twist the Lid Latches and open the board Lid.

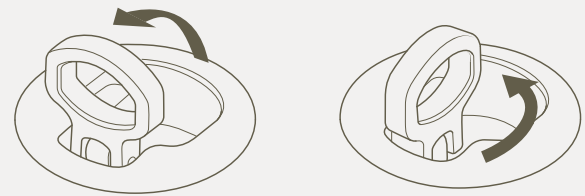

DO NOT OPEN LID WHILST IN THE WATER UNDER ANY CIRCUMSTANCES.

- 2 Take Flitecell by the handle and carefully lower it into the board cavity, ensuring to move cables out of the way first. The warning label should be facing up.

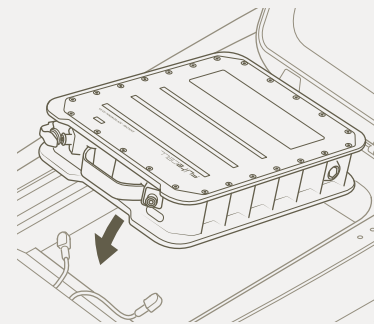

BE CAREFUL NOT TO DAMAGE THE BOARD SEAL WHEN FITTING FLITECELL. ANY KNICKS, CUTS OR DAMAGE TO THE SEAL MAY RESULT IN LEAKS.

BE CAREFUL NOT TO RECONNECT FLITECELL POWER CABLES, WITHIN 10 SECONDS OF DISCONNECTION TO AVOID A POSSIBLE ARC.

- 3 Connect the orange power cable to the orange power in Flitecell. You will feel a secure click when properly engaged.
- 4 Connect the black power cable to the black power in Flitecell.

Flitecell is now connected.

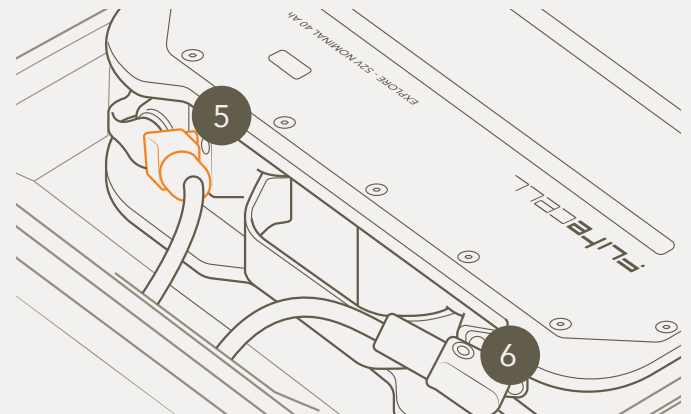

Turning on Fliteboard

- 1 Make certain nothing is caught in the seal. Carefully close the lid.
- 2 Twist and lock the two lid latches.
- 3 A few seconds after the lid is shut in position, you will hear a **'beep beep beep'** which signifies that the Flitecell and board have automatically turned on.
- 4 If the external board light is not active, open the lid and ensure the power cables are properly connected, and there are lights on the Flitecell indicating it is switched on.
- 5 Flitecell will automatically turn off 10 seconds after the lid is opened.

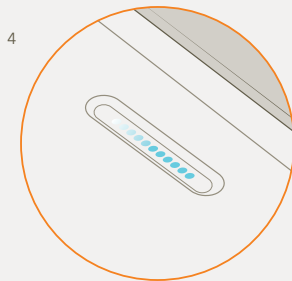
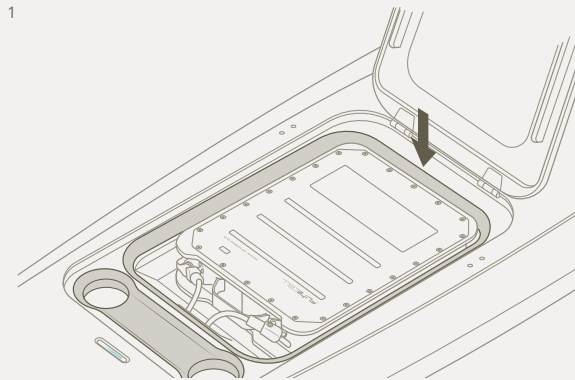

SEE PAGE 36 FOR PAIRING
FLITE CONTROLLER

THE SEAL IS A CRITICAL COMPONENT. IF DAMAGED CONTACT YOUR DEALER FOR A REPLACEMENT PART. NEVER RIDE THE BOARD WITH A DAMAGED SEAL.

THE FLITECELL AND CABLES ARE WATER RESISTANT; HOWEVER, ALWAYS KEEP FLITECELL, CABLES AND BOARD CAVITY DRY. WATER, ESPECIALLY SALT WATER, CAN ACCELERATE AGING AND CORROSION. IF YOUR BOARD LEAKS, CHECK SEALS, AND CLEAN COMPONENTS CAREFULLY.

Download Flite App and update

The Flite App is available to download in the Apple App Store*. We recommend using Flite App to ensure your board and controller always have the latest software to deliver the best performance.

*An Android version is in development and will be available from the Play store when ready. If you do not have an iPhone you may get your software updates at one of our Service Centres around the world visit fliteboard.com/locations



Download Flite APP
from App Store
iOS only, V10.7 or higher

Watch our Flite APP
update video
tinyurl.com/yb3vudw8

[apps.apple.com/
au/app/fliteboard/
id1499441319](https://apps.apple.com/au/app/fliteboard/id1499441319)

Performing first update

BEFORE YOU USE FLITE APP FOR THE FIRST TIME MAKE SURE THE PHONE, FLITECELL, FLITE CONTROLLER HAVE AT LEAST 20% CHARGE. KEEP THE PHONE CLOSE AND IN LINE OF SIGHT WITH A STRONG WIFI/CELLULAR NETWORK. DON'T USE THE PHONE FOR ANYTHING ELSE SUCH AS CALLS, TEXTS, OR OTHER APPS.

FLITEBOARD IS READY FOR ITS FIRST UPDATE BY ENSURING THAT IT IS ASSEMBLED AND POWERED ON.

MAKE SURE THE FLITEBOARD LID REMAINS CLOSED DURING THE UPDATE PROCESS.

ENSURE FLITE CONTROLLER IS TURNED OFF AS THE APP CAN ONLY CONNECT TO ONE DEVICE AT A TIME.

Open the app and agree to the onscreen prompts. You'll be taken to the first update process one step at a time. Follow the instructions carefully to update 1. Fliteboard, 2. eFoil and then finally follow instructions to turn on and update the 3. Flite Controller.

The Fliteboard update typically takes 2 - 3 minutes, eFoil update 2 - 3 minutes and Flite Controller 2 minutes.

You may need to wait 10 - 20 seconds for Fliteboard to restart between Fliteboard and eFoil updates. The Fliteboard LED may switch between flashing blue, solid purple or green.

Connecting Flite App to Fliteboard and the eFoil

- 1 Turn off Flite Controller.
- 2 Ensure Fliteboard has power and the lid is closed.
- 3 Select **'Fliteboard'** from the **'Devices'** menu. When connected, the board Flitebox LED will turn purple. When performing some updates it will display green.
- 4 You will now be able to see software version of both the Fliteboard and the eFoil.
- 5 Once connected you can perform ongoing updates and now sync session rides under **'Sessions'**

YOU WILL ONLY NEED TO USE FIRST UPDATE PROCESS ONCE. WHEN NEW SOFTWARE UPDATES ARE AVAILABLE, YOU'LL SEE AN ORANGE UPDATE ICON. WHEN UPDATING, DON'T USE THE PHONE FOR ANYTHING ELSE SUCH AS CALLS, TEXTS OR OTHER APPS.

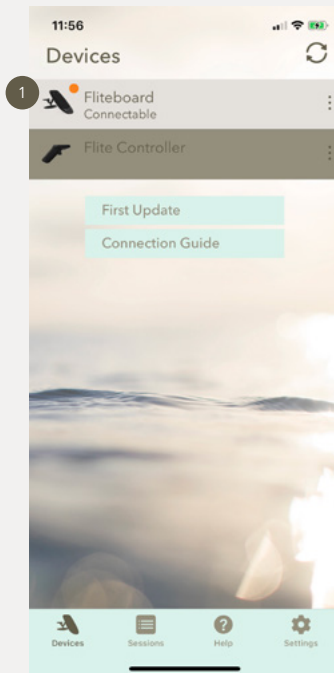

Devices

- 1 Fliteboard is turned on and connectable. New updates are denoted by the orange alert.

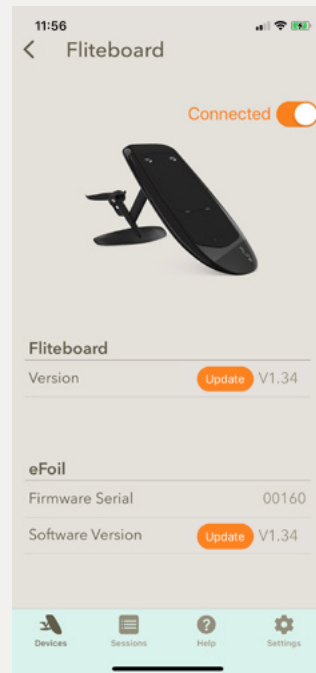

Devices / Fliteboard

- 1 Fliteboard is connected. Updates are both required and able to be performed for both Fliteboard and eFoil.

Connecting Flite App to Flite Controller

- 1 Turn off Fliteboard.
- 2 Ensure Flite Controller has power and within range to the phone.
- 3 Select **'Flite Controller'** from the **'Devices'** list. When selected and connected, the current state of charge will be displayed.
- 4 You will now be able to see software version of the Flite Controller and perform any updates here.

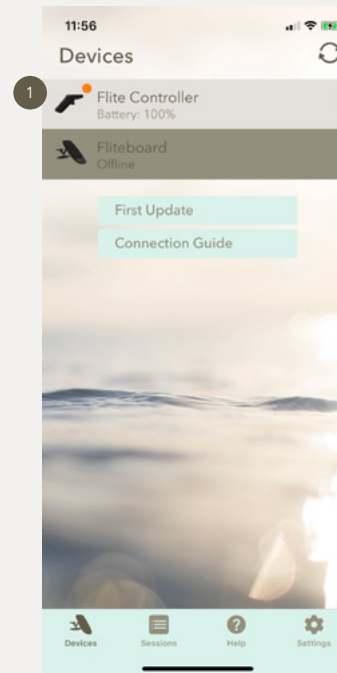

Devices

- 1 Flite Controller is turned on (allowing it to be discoverable in the devices list). Updates are denoted by the orange alert.

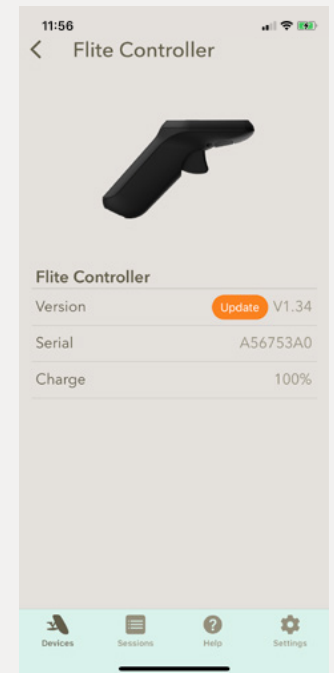

Devices / Flite Controller

- 1 Flite Controller is connected. Update by pressing orange 'update' icon.

IMPORTANT: ALWAYS UPDATE THE FLITEBOARD FIRST AND THEN EFOIL

Capturing sessions

- 1 Once software is up-to-date, Fliteboard will automatically capture sessions to its onboard computer.
- 2 Open Flite App. Click **'Sessions'** and then double tap **'Sync'** to view and download any new sessions.
- 3 Clicking the share icon (top right) from the **'Sessions'** screen will share diagnostic data with Fliteboard support via email.
- 4 Clicking a ride in the Sessions list, will then take you to ride detail screen. Here you can play back your ride in various speeds, over an aerial map.

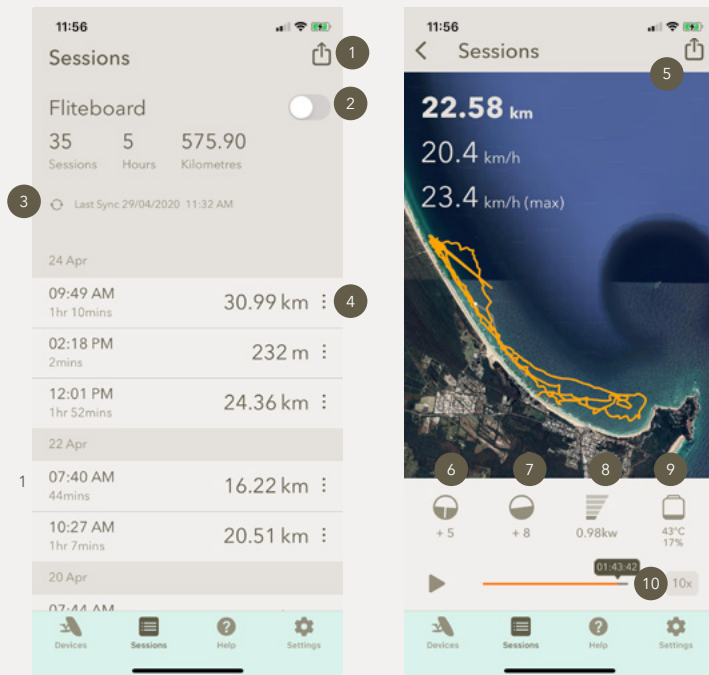

Sessions

- 1 Share diagnostics with support
- 2 Connect / disconnect (when powered and in range)
- 3 Sync sessions (when Fliteboard is connected)
- 4 Session ride (swipe left to rename)

Sessions / Ride detail

- 5 Share ride
- 6 Ride roll angle
- 7 Ride pitch angle
- 8 Power consumption
- 9 Flitecell temperature displayed in Celsius. Flitecell charge remaining
- 10 Adjust ride playback speed

Flite Controller overview

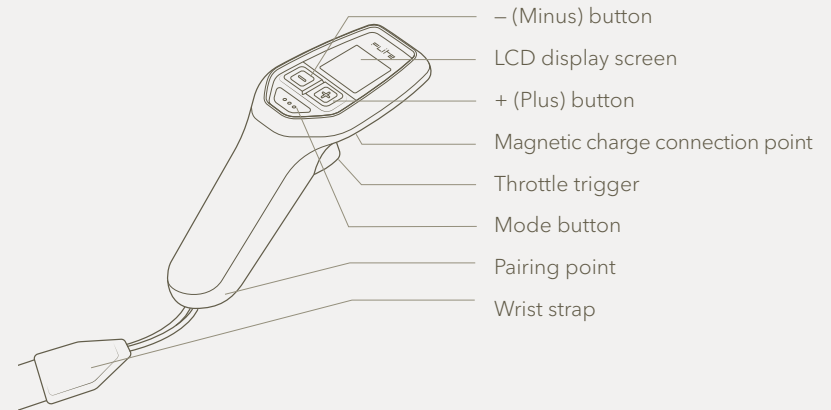

Turn on and connect Flite Controller

- 1 Turn on Flite Controller by holding down the + button AND Mode (bottom) button together for 3 seconds.
- 2 After a 3 second press of both buttons, the Flite logo will appear with the software version number, and the Controller will move to the home screen with lock icon.

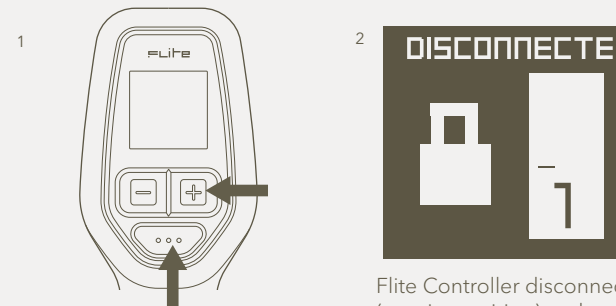

Flite Controller disconnected (requires pairing) and motor locked (requires arming). Power Level 1 (Gear 1).

Hold + button for 7 seconds to put into pairing mode.

IF THE REAR LIGHT HAS A BLUE SOLID LIGHT (NOT BLINKING) YOUR FLITE CONTROLLER IS CONNECTED. IF THE FLITEBOX LIGHT IS FLASHING YOUR CONTROLLER AND FLITEBOARD NEED TO BE PAIRED.

Flite Controller screen guide

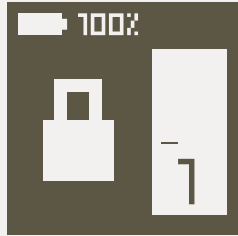

Motor locked

Ready to arm.
Flitecell 100% charged.
Power Level set to level 1.

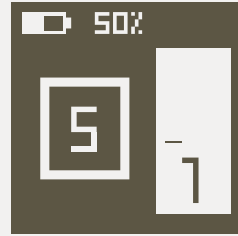

Motor armed

Motor unlocked with 5 seconds to squeeze the throttle trigger.
Flitecell charge 50%

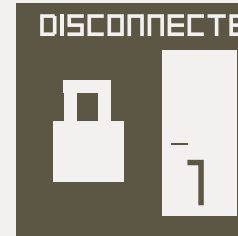

Disconnected (scrolling)

Flite Controller is not connected or under water.
Hold plus for 7 seconds until Flite Controller displays LOOKING FOR NEW PAIR.



Looking for new pair (scrolling)

Flite Controller is looking for a new pair. .

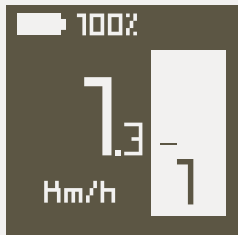

Current Speed / Power

Speed 1.3km/h
Power level 1



Distance

Traveled 6.4kms
Remaining 24.7kms
Current Speed 23.6km/h

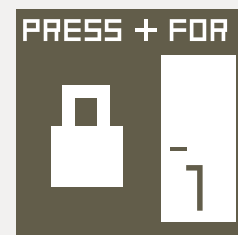

Pairing required

Flite Controller is not paired.
Hold plus for 7 seconds until Flite Controller displays LOOKING FOR NEW PAIR.

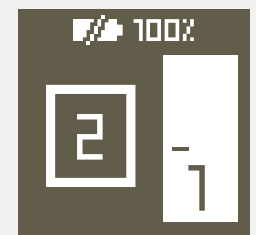

Battery not paired

Repeat pairing process (see page 36)



Time

Elapsed 60mins
Remaining 12mins
Current speed 23.6km/h



Speed

Maximum 35.1km/h
Average 13.2km/h
Current speed 23.6km/h



Diagnostics

Flitecell kilowatts 1.5
Prop RPM x 1000 = 2,100
ESC Temp 40 Degrees
Flitecell Temp 40 Degrees
Flitecell Charge 100%
Current Speed 23.6km/h



Efficiency

60 Wh/km
Flitecell charge 100%
Current speed 23.6km/h

Flite Controller screen guide



Charge remaining

Flitecell 98%
Flite Controller 66%



Flite Controller charging

Flite Controller currently
at 10% state of charge.

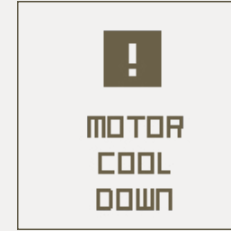

Motor Cool Down

The motor needs to cool
down. Fliteboard is limited
to low gears for 1 minute
to allow motor to cool.

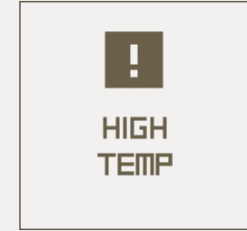

High Temp

Flitecell is too hot. Ride
using low power to allow
Flitecell to cool, otherwise
Flitecell may shut down.



50% Flitecell warning

Flitecell has 50% (or less)
remaining charge.

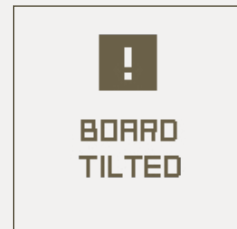

Fliteboard tilted

Fliteboard is disabled
due to the tilt angle.

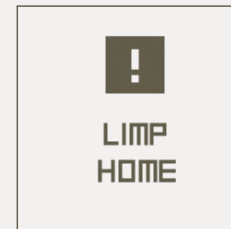

Flitecell charge critical

Flitecell charge very low,
immediately return to
shore. Fliteboard is limited
to low gears only to
conserve charge.



Flite Controller low charge

Flite Controller requires
charge. Ensure Flite
Controller is charged above
50% each ride.

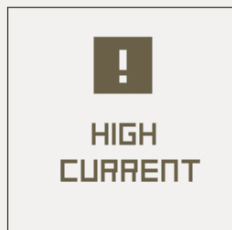

High Current

Motor Cool Down mode
will be activated if power
isn't reduced.

Pairing Flite Controller & Flitecell with Flitebox

- 1 Hold the + button for 7 seconds until the words 'PRESS MODE TO COMMENCE PAIRING' appear. Then press mode button to confirm. The words 'LOOKING FOR NEW PAIR' will appear.
- 2 Open the Fliteboard lid and place the Flitecell clip on the Flitecell to keep it powered on.
- 3 Place the base of the Flite controller on the pairing target on the Flitebox (between the Flitecell cables).
- 4 Whilst searching for a new pair, the LED lights at the rear of the board will display as Orange chasing (scrolling over and over).
- 5 Once paired successfully, the LEDs will change to a solid light blue colour.
- 6 Remove the Flitecell clip and shut the Fliteboard lid within **10 seconds** (before the Flitecell switches off and powers off the system)

DO NOT HOLD THE FLITE CONTROLLER IN THE PAIRING POSITION FOR MORE THAN 30 SECONDS. HOLDING THE FLITE CONTROLLER IN THIS POSITION WILL PUT THE BOARD INTO SOFTWARE UPDATE MODE.

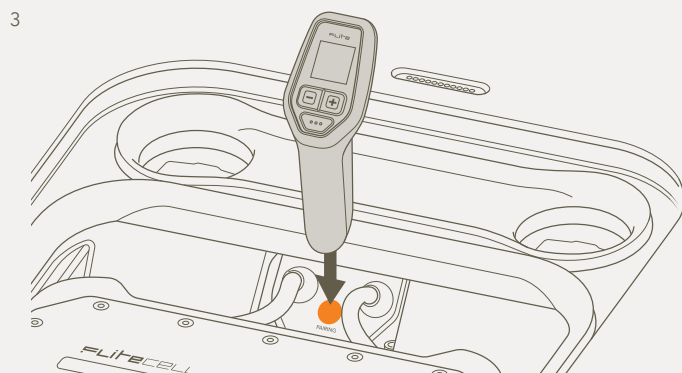
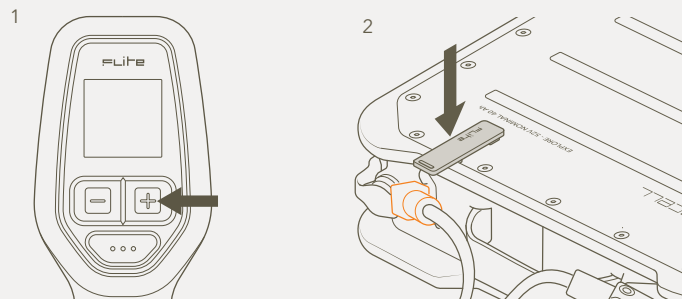

Flitebox light

Flite Controller meaning

	Light blue solid	Ready to ride
	Red flashing	Alert (high temp, tilt, overcurrent, system error)
	Blue flashing	Armed
	Blue chasing	Motor running
	Orange flashing	Disconnected Flitecell / Controller
	Orange chasing	Searching for new pair Flitecell / Controller
	Purple solid	Flite App connected
	Purple chasing	Flite App data transfer

Arming the motor

Fliteboard uses a safety lock to guarantee that riders cannot accidentally spin the propeller by bumping the throttle trigger unintentionally. Riders must arm (unlock) the motor to Fliteboard.

- 1 To arm the motor, pull the throttle all the way in on the Flite Controller and then release it completely.
- 2 Press and then release the minus button.
- 3 Pull the throttle trigger within 5 second countdown window to activate the propeller. Always verify the propeller is clear and in a safe location before activating the motor

IMPORTANT: NEVER RUN THE MOTOR OUT OF WATER FOR MORE THAN 3 SECONDS, AS DOING SO CAN OVERHEAT AND DAMAGE THE PROPELLER SHAFT AND SEALS.

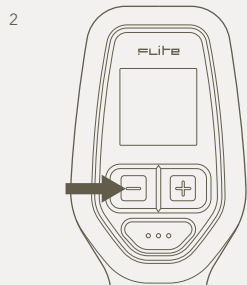
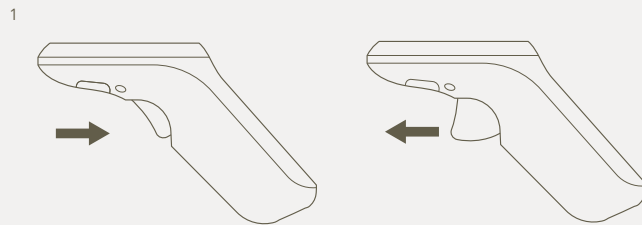

Countdown window appears pull the throttle trigger completely to activate propeller

Get Fliteboarding

Fliteboard recommends that first time riders have at least one lesson with a certified Fliteschool. To find your nearest Fliteschool visit fliteboard.com/locations

Select a suitable riding location

A location with deep enough water is essential. The Wings and eFoil should never make contact with anything below the surface, including a sand bottom. Be aware of tide times, as well as submerged items such as branches, coral, boat chains and fishing lines. If you are unsure about the local area ask someone who knows the waterway for advice. Be aware the board can be submerged with rider weight, reducing clearance required.

Choose a location away from swimmers and other water users and ensure local laws allow motorised craft to be used in the area.

Learning to Fliteboard in very smooth water without waves or strong currents is SIGNIFICANTLY easier and safer than learning in choppy water. Your first Fliteboard experience will be challenging (but rewarding) so choose a location and weather conditions that allow for the easiest possible learning experience.

Ride time and range are dependent upon:

- Rider weight
- Average speed
- Wing choice
- Water / wind conditions

ENSURING SAFE WATER DEPTH IS EXTREMELY IMPORTANT BEFORE RIDING. SELECT A LOCATION THAT IS HAS A MINIMUM DEPTH OF AT LEAST 1.5 METRES.

ALWAYS MONITOR FLITECELL LEVELS WHILE RIDING AND TAKE CARE NOT TO DEplete THE FLITECELL BEFORE RETURNING TO YOUR POINT OF ORIGIN.

NEVER RIDE FLITEBOARD FURTHER FROM SHORE THAN YOU ARE PREPARED TO SWIM BACK.

Engage the Motor and get moving

- 1 Climb onto the board, taking care not to kick the hydrofoil wings or mast.
- 2 Lie on the board, positioned so that you can touch the front of the Fliteboard with your hand (or the front handle if using the Fliteboard AIR).
- 3 Verify Flite Controller is set so you see power level '1' displayed on the lock screen. This is your starting power setting once unlocked (it can be changed later if you are an advanced rider).
- 4 Arm the motor and squeeze the throttle trigger. The board should start to move. You should be on power level 1 (a low power setting).
- 5 Practice riding lying on the board and changing speed using the buttons between level 1 and level 3. Be sure to keep enough weight on the front of the board to keep the nose of the board down and parallel to the water.

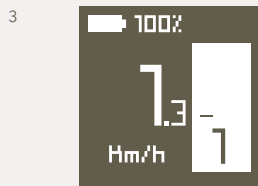
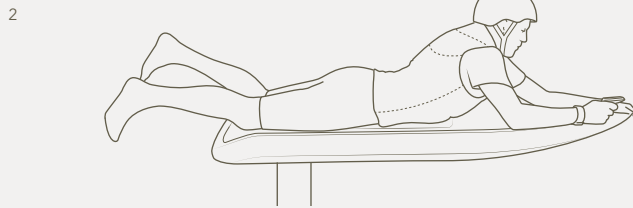
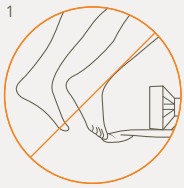

Getting to your knees

- 1 Once comfortable lying on the board, arming the motor, changing speed and riding the board lying down, it's time to get to your knees.
- 2 Depending on your weight, board and conditions, you may wish to move to your knees on power level 3, 4, 5 or 6. You want to be traveling fast enough that you won't nose dive or sink, but not so fast that you are bouncing over chop, planing quickly or starting to foil. A speed of 6 - 8 kph on the GPS display on the Flite Controller is a good speed for getting to your knees.
- 3 Place both hands on the board, smoothly push your body up and slide both knees under you onto the board. Your knees should be positioned just in front of the lid hinges. Be careful not to put your knees on the hinges themselves.
- 4 Keep your body weight forward to keep the nose down and the foil disengaged.

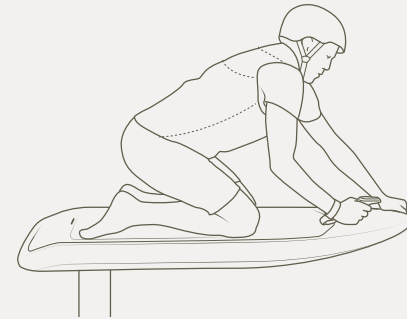

PRO TIP Fliteboard has been designed with a cruise control system in mind. Squeezing the trigger all the way in makes it easier to use your thumb to change the speed (from level 1 to 20). As you accelerate you may need to shuffle forward to keep the nose down.

PRO TIP Be careful not to let go of the throttle trigger as you move to your knees. You should practice maintaining a constant speed when changing body positions on the board.

Once you feel ready, you can practice starting to foil on your knees by carefully moving your head and upper body back. As soon as you hear the noise change from the board leaving the water, shift weight forward again to level off the foil or to touch down again.

Standing up

Check that you have clear flat water in front of you with no obstacles or other vessels.

Select a speed where the board feels stable. The ideal speed depends on your weight and board choice, but between 8kph and 12kph is a good speed to stand up.

- 1 While being careful not to let go of the throttle trigger (so you maintain a constant speed) place your front foot in the space in front of your knees. Your toes should be near the front of the foot pad and slightly to one side. (Refer to the diagram in the below PRO TIP)

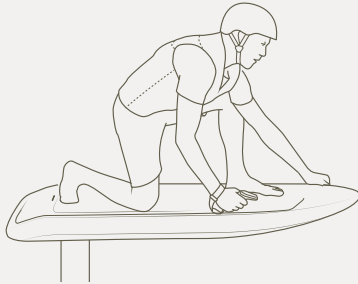

- 2 Take a moment to get your balance. Then, stand up, with as much weight as possible pushing through your front foot. This should feel like standing from a lunge position. Keeping your weight on your front foot keeps the board and nose down, which in turn keeps the foil in the water. Standing up with weight on your rear foot can result in the foil engaging and then an unintended crash.
- 3 Once standing keep your weight forward over your front knee. Your chest and nose should be lined up with, or in front of your front knee.

PRO TIP The ideal body position is with your body twisted forward, with front foot just behind the front of the deck grip, and rear foot 10cm in front of the latches, with both feet hip width apart. This stance is similar to the 'Warrior One' Yoga stance. This riding stance keeps your weight forward allowing good control over the pitching of the board forward, aft, left and right.

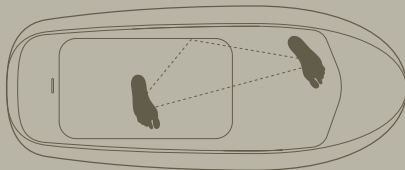

- 4 Once standing, practice slowly adding speed, but always while pushing down hard through your front leg. The foil, motor and your own bow wave will want to push the nose up. Push down hard and practice accelerating to planing speed, with the board flat on the water. Taking your weight off your front foot will engage the foil and likely result in a crash until you have learned to balance the foil.

Foiling for the first time

Like learning to ride a bike for the first time, learning to foil is challenging as it requires your brain to learn a new way to balance. There is also potential for you to fall on the Wings if not careful. Wear appropriate safety equipment including a Helmet and PFD, take your time and follow these steps.

Once comfortable standing at medium speeds, practice going faster with as much weight as possible over your front foot. Unlike surfing, you control the board more with your front foot. Weight on your front foot with your body leaning forward is safe - as it keeps the foil in the water. Whenever you become uncomfortable, lean forward toward the nose of the board. This will ensure the board is on the water and stable.

- 1 Practice standing in the riders stance and gradually increase your speed. The initial goal is to be able to ride at safe foiling speed (so you are in control and still within local laws) with the board still on the water. You do this by keeping your weight forward.
- 2 While planing at the correct speed with your feet in the correct position and the board LEVEL on the water; very gradually start to transfer weight backwards. You will feel slightly less pressure on your front foot and more pressure on the back foot. Do this carefully, with your weight over the centre line of the board and your core engaged.
- 3 As soon as you feel the board leave the water (you will hear the noise change) lean forward again and touch down. The goal is to foil as LOW as possible for very short sections. Foiling for 5 meters at a time and then touching down again is all you need to do.

Practice this and your brain will work out the rest. Before long you will be foiling for longer periods and then continuously.

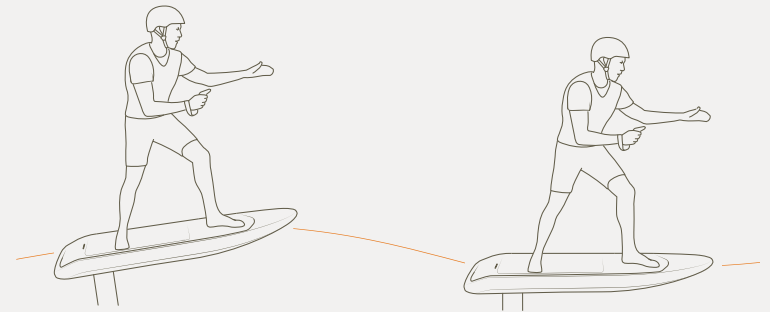

Don't go too high

More pressure on front foot

PRO TIP The safest and easiest way to learn to foil is to foil low and practice repeated touch and go's. As you foil higher you expose yourself to the risk of a crash where you could hit the wings. You may lose your confidence and learning will take longer.

Foiling pro tips

If you shift your weight too far to one side, it is not possible to recover. Jump away from the board in the direction you are falling. This takes you SAFELY away from the foil.

Keep your weight forward and press down through your front knee. Confirm your feet are in the correct position.

Don't vary your speed too quickly, it may unsettle the foil and make balance more difficult. Like an aeroplane, the foil wings need a constant speed for smooth flying.

Don't try to foil going too slow. The wings will stall and you may crash.

Don't try to turn on the foil until you are very comfortable in a straight line.

Keep the board flat and level.

Foiling through turns

Turning while foiling requires careful balance on all axes.

Start by doing very wide turns.

As you gain experience you can try tighter turns.

Keep speed constant.

In tight turns you will need to apply more force to your back leg to maintain foil altitude (like an aeroplane adding elevator through a turn).

All of this might sound complex, but if you keep your weight forward, practice in flat water, maintain constant speed, and take learning step by step, you will likely be foiling in no time.

Maintenance and Storage

READ THROUGH THE ENTIRE STORAGE AND MAINTENANCE INSTRUCTIONS BEFORE STORING YOUR BOARD.

- 1 It is essential that your Fliteboard be serviced as per the 'Maintenance schedule' at the end of this manual to retain its high level of performance, safety and reliability, including warranty, as mentioned previous.
- 2 The service intervals are in both hrs or months, whichever comes first.
- 3 The service schedule and intervals assume you will use your Fliteboard in accordance with our guidelines.

Periodic Checks

- 1 Ensure that you view our 'Care and Maintenance video' <https://www.youtube.com/watch?v=zCf26ILCV2g> before first using your Fliteboard.
- 2 Ensure that after each session, you visually inspect all elements of Fliteboard including board, wings, mast, Flitecell and Flite Controller for any damage or water ingress.
- 3 Ensure that you perform the 6 Month Flitecell Checklist located on the Support Page on the website.
- 4 Ensure all connections are clean, free from corrosion and damage after each use.

Maintenance Schedule Intervals

The hour/months intervals shown in the maintenance schedule section of the manual are intended as a guide. If you are operate a Fliteschool then supplementary servicing may be necessary.

Please contact support@fliteboard.com for any queries or questions.

Fliteboard, PRO, ULTRA

Post ride

Open the board lid slowly, take care not to let it fall on the nose of the board. (If the lid is opened too far it may fall and damage the nose of the board).

After each ride, check to see if any water has leaked into the Flitecell cavity.

If so, check the cause of the leak which may include: sand present on the sealing surface; a damaged or dislocated seal; damaged hinges or latches; or something obstructing the lid when closed.

Once the Flitecell has been removed ensure that the complete board, including Flitecell compartment, seals, lid and eFoil are washed thoroughly in fresh water.

Let the board air dry and then wipe down with a clean, dry absorbent cloth. Ensure that Contact Cleaner is sprayed onto all connections.

Regular maintenance

Apply lubricant / WD40 to the latches and hinges every few weeks. Keep the lubricant away from the deck grip to avoid a slippery board.

Check the board regularly for damage or cracks. If damage is present have it repaired by a professional surfboard or sailboard repairer who is experienced with epoxy repairs.

Inspect the orange, mast flange seal regularly for any damage and ensure its is kept clean and free of any sand, grit or dirt.

During daily use ensure that the eFoil is removed from the board and wings from the eFoil at least every three days. Ensure Contact Cleaner is applied to all cables and Tef-Gel is reapplied to all screws.

Storage

Ensure that all sand, grit, dirt, and salt residue has been washed off with fresh water, and sufficiently dried. Ensure that the Flitecell has been wiped down with a clean, dry absorbent cloth while switched off.

Ensure the board and deck grip are dry before storage.

Apply Contact Cleaner to all connectors to reduce the risk of corrosion.

Take extra care not to scratch the carbon board bottom and wings.

Place your Fliteboard in the provided bag, then store in a clean and dry environment.

Keep the board and bag out of the sun.

Fliteboard AIR

Post ride

Wash the inflatable bladder with warm soapy water and dry before storage.

The inflatable bladder can remain inflated, or be deflated and stored on or off the carbon insert to suit your storage preference.

Regular maintenance

The inflatable bladder can be repaired using the supplied repair kit. 15 - 16 PSI is the recommended inflation pressure.

eFoil

Post ride

Disconnect the Flitecell power cables.

Rinse thoroughly with clean fresh water after every use.

Rinse the inside of the mast (through the notch in the rear of the flange) with fresh water.

Rinse around the mast flange to wash salt away from the board connection area (if keeping the board and foil attached).

Regular maintenance

Disassemble the eFoil from the board.

Remove the wing, fuselage cover and tail, and clean thoroughly with fresh soapy water to remove any built-up salt or sand.

Storage

Always store the eFoil in a clean, dry environment.

Flite Controller

Post ride

Rinse the Flite Controller in fresh water to clean away salt and debris. Ensure a steady stream of fresh water is applied directly into the trigger housing. While doing so press and de-press the trigger numerous times to loosen any sand, grit, debris that may affect its performance.

Peel out the rubber cover on the underside and clean this with fresh water. Ensure this area is dry before replacing the cover.

Regular maintenance

Pre and post season, the 3 torque screws on the underside of the controller can be undone to release the trigger. This will allow you thoroughly clean and inspect both the trigger, spring and magnet.

Storage

Store in a cool dry place, out of the sun.

Flitecell

Post ride

Wipe Flitecell down with a wet cloth (freshwater), and clean Flitecell contacts and data connector with Contact Cleaner.

Flitecell is water resistant but it should remain dry where possible. DO NOT submerge or shower.

Avoid placing Flitecell on the sand, which can make its way into the Flitecell cavity and scratch surfaces.

DO NOT charge the Flitecell immediately after use. The Flitecell temperature may be too high. Allow 30mins between riding and charging to allow for cooling.

DO NOT clean the Flitecell or charger with denatured alcohol or other flammable solvents.

IF THE BOARD HAS LEAKED AND / OR THE FLITECELL HAS BEEN SUBMERGED IN WATER, INSPECT FOR WATER INGRESS USING THE SIGHT GLASS LOCATED ON THE SIDE OF THE FLITECELL. STAND THE FLITECELL UP ON ITS BOTTOM END FOR ONE MINUTE AND THEN PLACE THE FLITECELL ON ITS SIDE WITH THE SIGHT GLASS FACING DOWN FOR ONE MINUTE. INSIDE THE SIGHTGLASS IS A COLOUR CHANGING LABEL WHICH WILL TURN RED IF WATER IS PRESENT. INSPECT THE SIGHT GLASS AND CONFIRM THAT WATER IS NOT PRESENT BEFORE CHARGING AND USING A FLITECELL THAT HAS BEEN IMMERSSED IN WATER.

IF A FLITECELL HAS BEEN DROPPED OR DAMAGED, CONTACT FLITEBOARD IMMEDIATELY AND DO NOT USE THE FLITECELL.

Regular maintenance

Examine the charger regularly for damage to the cord, plug, enclosure or other parts.

Storage

Keep Flitecell stored out of the reach of children and pets.

DO NOT store the Flitecell near heat sources such as a furnace or heater. DO NOT leave the Flitecell inside of a vehicle on hot days. The ideal storage temperature is 22°C - 28°C.

Do NOT store the Flitecell whilst charging. Disconnect the charger when not in use.

DO NOT store the Flitecell fully charged or discharged for a longer period of time.

For long term storage a charge state of 75% (2 LEDs on) is optimal.

We recommend that you discharge the Flitecell during your final session of the season and charge back up to the above state.

Shipping and transport

Flitecell (batteries) are considered a dangerous good and must not be shipped without working with a dangerous goods shipping specialist.

Shipping batteries marked as normal goods without informing the shipping party is illegal and dangerous. The Material Safety Data Sheet (MSDS) is required for shipping the batteries.

Issue	Troubleshooting guide
Fliteboard starts to slow or 'limp'	This is a sign your Flitecell is about to run down or over heat. Move out of the water and recharge your Flitecell. Refer to the Flitecell charging instructions.
Fliteboard turns off while riding	Move out of the water to a safe, dry, clean area. Check the LED on Flitecell to confirm if it still has charge. If it has charge, disconnect and reconnect the Flitecell to see if you can establish a connection. Inspect the Flitecell for water or damage. There should be no water inside the Flitecell housing.
Flite Controller disconnects	Re-arm the Flite Controller. See arming instructions.
Flite Controller unpairs	Re-pair the Flite Controller. See pairing instructions.
Flitecell charger won't connect	Disconnect and reconnect. Contact Fliteboard Customer Support.
Flite Controller won't turn on	Ensure Flite Controller is fully charged. See Flite Controller charging instructions.
Flite Controller shows a battery warning	Slow down or decrease power consumption to cool the Flitecell down. The Flite Controller will warn you when the Flitecell temperature reaches 55°C and again at 60°C. At 65°C the Flitecell will automatically start to shut down to preserve itself.
Water in the Fliteboard cavity	Remove the board from the water. Remove the Flitecell. Dry the board completely. Check the Flitecell for leaks. If the Flitecell has taken in water refer to the section below. Once dried and re-assembled, take care that the Fliteboard Cavity seal is properly compressed when closing the Fliteboard lid.
Water in Flitecell	Flitecell has an indicator for water damage. If water has penetrated the casing, regularly check the circular water indicator on the side of your Flitecell. If the sticker has turned red, this means water has penetrated the housing. IF WATER HAS PENETRATED THE FLITECELL, PLEASE SET FLITECELL ASIDE IN A COOL DRY PLACE. DO NOT ATTEMPT TO USE A FLITECELL THAT HAS BEEN WATERLOGGED. CONTACT FLITEBOARD IMMEDIATELY.
Unable to pair Flite Controller	Please ensure no other controllers or boards are switched on. Try again as per pairing instructions.
Unable to pair Flite Controllers to multiple boards	Do not attempt to pair multiple Flite Controllers to multiple Fliteboards simultaneously. Always pair one at a time.
Reduced runtime	The battery management system (BMS) balances and optimises the battery during each charge cycle. Leave the charging magnet on Flitecell for 24 - 48 hours after between charges to allow the BMS to optimise Flitecell.

Technical Specifications

Speed	Up to 45 kph / 28 mph
Rated load range	100kg / 220 lbs
Run time 85kg rider	Up to 1 hr 30 min (Flitecell Explore) Using a large wing at slow foiling speed, it's possible to ride for over 2 hours.

Board details	KG	LBS	MEASUREMENTS	L
Fliteboard ULTRA	8.8	19	1310 L x 585 W x 110MM D (4'2" x 23" x 4 3/8")	54
Fliteboard PRO	9.1	20	1550 L x 600 W x 110MM D (5'0" x 24" x 4 3/8")	67
Fliteboard	11.8	26	1735 L x 650 W x 125MM D (5'8" x 26" x 5")	100
Fliteboard AIR	11.8	26	1850 L x 770 W x 135MM D (6'0" x 30" x 5 3/8")	150

Fliteboard, PRO and ULTRA

Materials	Carbon Fibre, Innegra, aircraft grade aluminium, high quality wood laminates and composites.
------------------	--

Fliteboard AIR materials

Type	Inflatable
Materials	Grey Selytech Composite Super Light Drop Stitch Fabric / PVC / EVA
Pressure	15 - 16 PSI

Travel case

Fliteboard ULTRA	1390 x 670 x 170mm (4'5" x 2'3" x 6' 3/8")
Fliteboard PRO	1630 x 700 x 170mm (5'3" x 2'3" x 6' 3/8")
Fliteboard	1800 x 760 x 170mm (6' x 2'5" x 6' 3/8")
Fliteboard AIR	1220 x 600 x 300mm (7'2" x 2' x 12")
eFoil case	1100 x 640 x 260mm (3'8" x 2'2" x 10")
Flitecell travel bag	450 x 370 x 90mm (5'3" x 2'3" x 3' 5/8")

eFoil system

Input power	5,000 Watts
Max output power at shaft	3,700 Watts
Nominal voltage	52v
Maximum current	100 AMPS
Motor type	Brushless
Motor speed	4500 rpm propeller peak
Protections	Overheating, overcurrent
Propeller diameter	142mm
Propeller guard	155mm

Flite Controller

Communication Type	Bluetooth
Speed Control	20 step display
Runtime	Average charge 24 hrs / Standby 200 hrs
Rated cycles	1000 charge cycles
Protection grade	IP67

Premium 25A Charger

Charging current	25 AMP
Charge time	1hr 45min Flitecell Explore 1hr 15min Flitecell Sport

Flitecell Sport

Size	315mm x 305mm x 80mm (15" x 12" x 13")
Capacity	30Ah / 1.5KWh
Weight	10.9kg (24 lbs)
Protection	IP67
Max charge voltage	58.8v
Min voltage	42v
Nominal voltage	52v
Rated continuous discharge current	100a
Rated charge current	25a
Rated cycles >80% capacity	400 Cycles
Temperature discharge limits	0 - 70 Degrees C
Temperature charge limits	0 - 50 Degrees C
Communication	Bluetooth Protocol 2.0b
BMS critical functions	Balancing, Over-temperature (Charge/Discharge) Over-current, short-circuit protection, reverse polarity and over & under voltage
Other safety	3 levels of fusing adds redundancy if BMS failure occurs. Conformal / Resin coatings used on PCB's

Flitecell Explore

Size	390mm x 305mm x 80mm (15" x 12" x 13")
Capacity	40Ah / 2.1KWh
Weight	13.9kg (31 lbs)
Protection	IP67
Max charge voltage	58.8v
Min voltage	42v
Nominal voltage	52v
Rated continuous discharge current	100a
Rated charge current	25a
Rated cycles >80% capacity	400 Cycles
Temperature discharge limits	0 - 70 Degrees C
Temperature charge limits	0 - 50 Degrees C
Communication	Bluetooth Protocol 2.0b
BMS critical functions	Balancing, Over-temperature (Charge / Discharge) Over-current, short-circuit protection, reverse polarity and over & under voltage
Other safety	3 levels of fusing adds redundancy if BMS failure occurs. Conformal /resin coatings used on PCB's

Warranty Registration / Details of Purchase

Customer Name

Business Name
(if applicable)

Country & State

Purchased from

Date of Purchase

Board Type & serial number

eFoil Type

75cm

60cm

eFoil serial number

Flitecell Type

Explore

Sport

Flitecell serial number(s)

Flite Controller serial number(s)

Flitecell Charger serial number

Maintenance Schedule

FIRST 6 MONTH SERVICE

Inspected

Mast

Fuselage

Flitebox

Cables

Propeller Duct

Propeller

Replaced

Seals

Oil

Flitebox Gore vent

Cables

Propeller Duct

Propeller

Anode

eFoil Hours of use

Date

Name of Technician

Signature of Technician

Authorised Repair Centre

Maintenance Schedule

100HR/12 MONTH SERVICE

WHICHEVER COMES FIRST

Inspected

Mast

Fuselage

Flitebox

Cables

Propeller Duct

Propeller

Replaced

Seals

Oil

Flitebox Gore vent

Cables

Propeller Duct

Propeller

Anode

eFoil Hours of use

Date

Name of Technician

Signature of Technician

Authorised Repair Centre

Maintenance Schedule

200HR/24 MONTH SERVICE

WHICHEVER COMES FIRST

Inspected

Mast

Fuselage

Flitebox

Cables

Propeller Duct

Propeller

Replaced

Seals

Oil

Flitebox Gore vent

Cables

Propeller Duct

Propeller

Anode

eFoil Hours of use

Date

Name of Technician

Signature of Technician

Authorised Repair Centre

Maintenance Schedule

300HR/36 MONTH SERVICE

WHICHEVER COMES FIRST

Inspected

Mast

Fuselage

Flitebox

Cables

Propeller Duct

Propeller

Replaced

Seals

Oil

Flitebox Gore vent

Cables

Propeller Duct

Propeller

Anode

eFoil Hours of use

Date

Name of Technician

Signature of Technician

Authorised Repair Centre

Maintenance Schedule

400HR/48 MONTH SERVICE

WHICHEVER COMES FIRST

Inspected

Mast

Fuselage

Flitebox

Cables

Propeller Duct

Propeller

Replaced

Seals

Oil

Flitebox Gore vent

Cables

Propeller Duct

Propeller

Anode

eFoil Hours of use

Date

Name of Technician

Signature of Technician

Authorised Repair Centre

Maintenance Schedule

500HR/60 MONTH SERVICE

WHICHEVER COMES FIRST

Inspected

Mast

Fuselage

Flitebox

Cables

Propeller Duct

Propeller

Replaced

Seals

Oil

Flitebox Gore vent

Cables

Propeller Duct

Propeller

Anode

eFoil Hours of use

Date

Name of Technician

Signature of Technician

Authorised Repair Centre

